



Quick Installation Guide

Applicable Models

AS6504RD / AS6504RS / AS6512RD

Ver. 3.5.5.0120

Table of Contents

Notices	3
Safety Precautions	4
1. Package Contents	5
2. Optional Accessories	6
3. Hardware Installation Guide	7
Tools Needed for Hard Disk Installation	7
Hard Disk Installation	7
Connecting and Powering on the NAS	9
Upgrading System Memory.....	10
Installing Memory	13
Installing Expansion Card	15
Rail Kit Installation.....	16
Replace Malfunctioning PSU	18
4. Software Installation Guide.....	20
Download Center Installation	20
Web Installation	22
Installation Using a Mobile Device.....	23
Installation Using a Direct Connection.....	25
Shutting Down Your NAS.....	25
5. Appendix.....	27
LED Indicators.....	27
Rear Panel.....	28
Troubleshooting	29

Notices



Federal Communications Commission Statement

This device complies with FCC Rules Part 15. Operation is subject to the following two conditions:

- ➔ This device may not cause harmful interference.
- ➔ This device must accept any interference received, including interference that may cause undesired operation.

This equipment has been tested and found to comply with the limits for a class A digital device, pursuant to Part 15 of the Federal Communications Commission (FCC) rules. These limits are designed to provide reasonable protection against harmful interference in a residential installation. This equipment generates, uses, and can radiate radio frequency energy and, if not installed and used in accordance with the instructions, may cause harmful interference to radio communications. However, there is no guarantee that interference will not occur in a particular installation. If this equipment does cause harmful interference to radio or television reception, which can be determined by turning the equipment off and on, the user is encouraged to try to correct the interference by one or more of the following measures:

- ➔ Reorient or relocate the receiving antenna.
- ➔ Increase the separation between the equipment and receiver.
- ➔ Connect the equipment into an outlet on a circuit different from that to which the receiver is connected.
- ➔ Consult the dealer or an experienced radio/TV technician for help.

Changes or modifications not expressly approved by the party responsible for compliance could void the user's authority to operate the equipment.

CE Mark Warning



CE marking for devices without wireless LAN/Bluetooth

The shipped version of this device complies with the requirements of the EEC directives 2004/108/EC "Electromagnetic compatibility" and IEC60950-1:2005 (2nd Edition)+A1:2009 "Information technology equipment-Safety".

Safety Precautions

The following safety precautions will increase the life of the NAS. Follow all precautions and instructions.

Electrical Safety

Unplug this product from the power source before cleaning.

Use only the bundled power adapter. Using other power adapters may damage your device.

Ensure that you plug the power adapter to the correct power input rating. Check the label on the power adapter for the power rating.

Operation Safety

- DO NOT place this product in a location where it may get wet.
- Place this product on a flat and stable surface.
- Use this product in environments with an ambient temperature between 0°C and 40°C.
- DO NOT block the air vents on the case of this product. Always provide proper ventilation for this product.
- DO NOT insert any object or spill liquid into the air vents. If you encounter technical problems with this product, contact a qualified service technician or your retailer. DO NOT attempt to repair this product yourself.



DO NOT throw this product in municipal waste.

This product has been designed to enable proper reuse of parts and recycling. This symbol of the crossed out wheeled bin indicates that the product (electrical and electronic equipment) should not be placed in municipal waste. Check local regulations for disposal of electronic products.

Information on Minimum Support Timeframe for Security Updates







Scanning the QR code to the left will direct you to a page describing ASUSTOR's policies in regards to guaranteed timeframes for security updates in ADM for ASUSTOR NAS devices. This policy applies to ASUSTOR products worldwide and is additionally compliant with the UK's PSTI Act.



asustor.com/ptsi

1. Package Contents

Applicable Models: AS6504RD, AS6504RS, AS6512RD

Model Name			
	AS6504RD	AS6504RS	AS6512RD
 Power Cord	x2	x1	x2
 RJ45 Network Cable	x2		x2
 Screws for use with 3.5\" HDD	x16		x48
 Screws for use with 2.5\" HDD	x16		x48
 Quick Start Guide	x1		x1

2. Optional Accessories

The items below may be purchased from the ASUSTOR Accessories Store <http://shop.asustor.com>.

3. Hardware Installation Guide

All data stored on the hard disk(s) will be erased and CANNOT be recovered. Please back up all important data before initializing the system.

Tools Needed for Hard Disk Installation

- Phillips head screwdriver
- At least one 2.5 or 3.5 inch SATA hard disk. (For a list of compatible hard disks, please see <http://www.asustor.com/service/hd?id=hd>)

Hard Disk Installation

1. Press the button on the lower portion of the hard disk tray to release the latch.



2. Using the latch, gently pull the disk tray out of the disk bay.



3. Mount the hard disk to the disk tray.
 - ✓ **3.5-inch hard disks:** Place the hard disk into the disk tray, making sure that the mounting holes on the sides of the hard disk and disk tray are lined up. Secure the drive with four screws.



- ✓ **2.5-inch hard disks and SSD hard disks:** Place the hard disk into the area of the disk tray outlined in red (see picture below). Make sure that the mounting holes on the bottom of the hard disk and disk tray are lined up. Secure the drive with four screws.

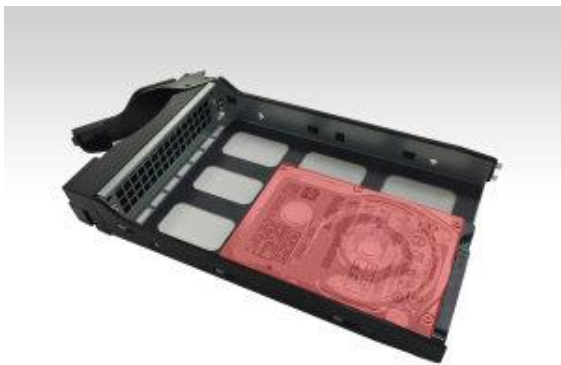

4. Slide the disk tray onto the rails of the disk bay. Using the latch, gently push the disk tray all the way into the disk bay. Secure the disk tray in place by pushing down on the latch. The latch should close easily and snap in with an audible 'click'. Please make sure that the disk tray is pushed all the way into the disk bay before attempting to secure the latch.

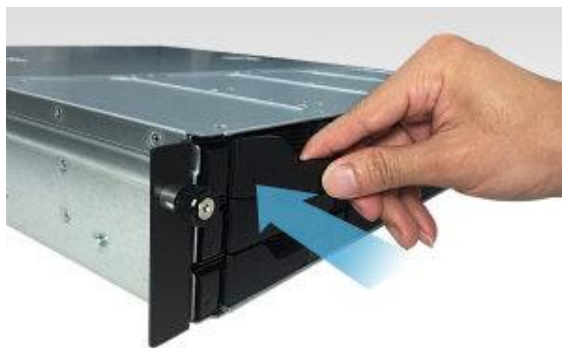

5. Once the latch is secure, you can lock it in place using the disk tray lock. Using a flathead screwdriver, turn the lock counterclockwise to lock the latch mechanism. Turning the lock clockwise will unlock it.



Connecting and Powering on the NAS

1. Connect the NAS to its power supply.

AS6504RS



AS6504RD

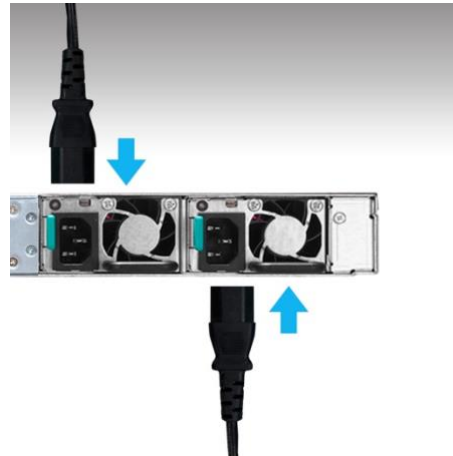

AS6512RD

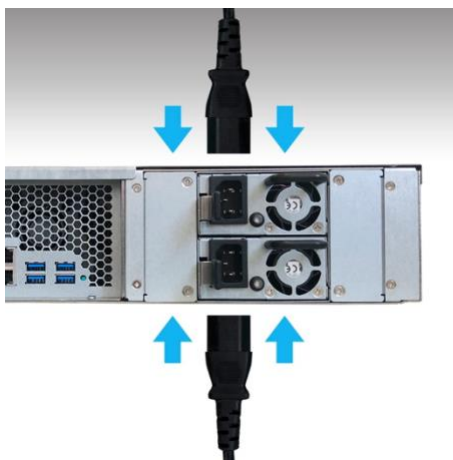

2. Connect the NAS to your router, switch or hub using an Ethernet cable.

AS6504RS/AS6504RD

AS6512RD

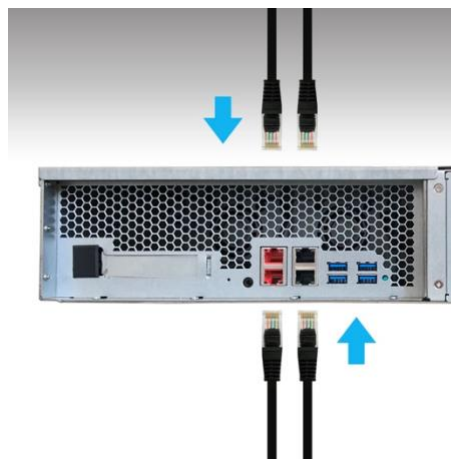
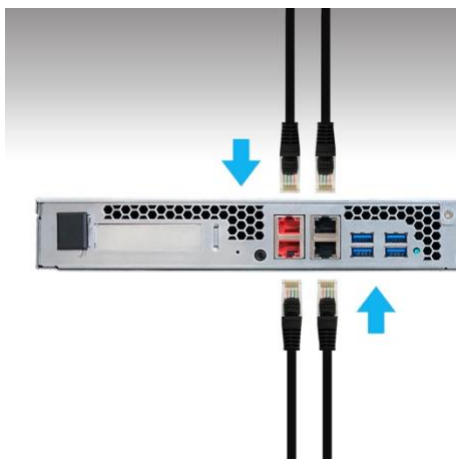

3. Press and hold down the power button for 1 – 2 seconds until the blue power LED indicator is lit. This indicates that the NAS is now powered on. While the NAS is being powered on, the green system status LED indicator will flash and the blue network LED indicator will be lit as well.



4. The NAS is ready for operation once the green system status LED indicator has stopped flashing and remains steadily lit. At this time, you should also hear a 'beep' from the system buzzer. Hardware installation is now complete. Please move on to the software installation guide to configure your system settings.

Upgrading System Memory

Notes and Precautions

All AS65XXR Series NAS devices support up to 128GB of memory. Before adding or removing memory modules, please read the following precautions thoroughly.

- Your NAS and memory modules use high precision components and electronic connector technology. To avoid invalidation of the warranty during your product warranty period, we recommend that:
 - ✓ Memory for AS65XXR series devices may be purchased from local dealers or the online ASUSTOR Accessories Store (<http://shop.asustor.com>).
 - ✓ You should not install a memory module by yourself, if you are not familiar with upgrading memory on a computer.
 - ✓ You should not touch the connectors or open the memory module compartment cover.
- Addition or removal of memory modules by yourself may result in an accident or malfunction of your NAS caused by breakage of the slot and module or a connection mistake. In this case, a repair fee will be charged.

- Be careful not to injure your hands or fingers with sharp edges of the memory module, inner components, or circuit boards of your NAS.
- ASUSTOR does not guarantee that third party memory modules will work in your NAS.
- Be sure to turn off your NAS and peripherals and disconnect all attachments and connection cables before adding or removing memory modules.
- To prevent damage from electrostatic discharge to memory modules, follow the instructions below:
 - ✓ Do not work at a location that produces static electricity easily, such as on a carpet.
 - ✓ Before adding or removing memory modules, touch an external metal object other than your NAS to ground yourself and eliminate static electricity. Do not touch any metal parts inside the NAS.
- Do not insert a memory module into the slot facing in the wrong direction. It may cause damage to the module or slot, or cause the circuit board to catch fire.
- Use a screwdriver that matches the size of the screws.
- Do not remove or loosen screws that are not specified to be removed.

Parts and Tools Needed

- ✓ Phillips head screwdriver

Removing the Cover

1. Shutdown the NAS by selecting [Shut down] from the ADM User Menu.



2. Disconnect all cables and devices connected to the NAS including the power cord.

AS6504RS



AS6504RD

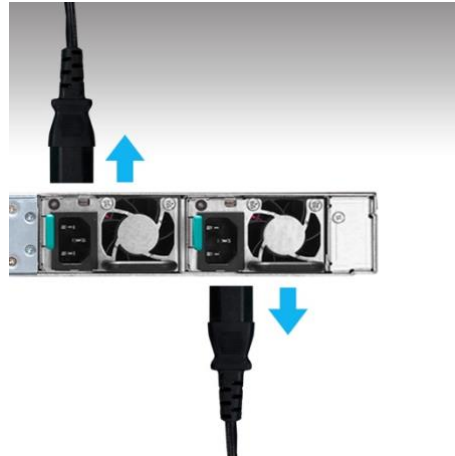

AS6512RD

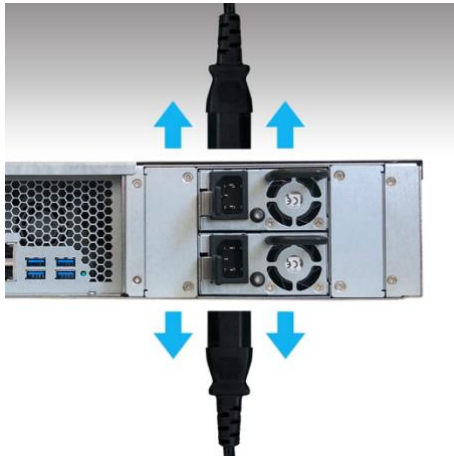

3. Use a screwdriver to loosen the three screws found on the rear of the NAS as shown in the illustration.

AS6504RS



AS6504RD



AS6512RD



4. Grip the cover from both sides with two hands and then gently push it back to remove it from the chassis.

AS6504RS/AS6504RD

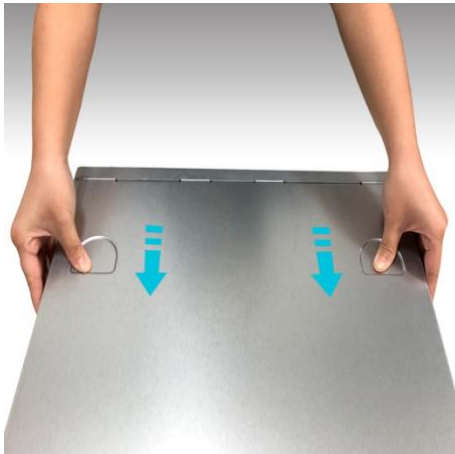

AS6512RD

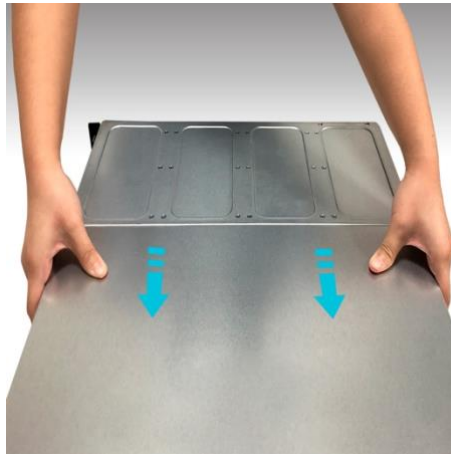

Installing Memory

When installing a memory module, follow the steps outlined below.

1. For each slot, diagonally slide in a new memory module (as shown in the graphic below) making sure that each memory module's connectors are fully inserted into the slot.



- Using two fingers, carefully push down and then back on the memory module until it clicks into place. You should be able to hear an audible “click”.

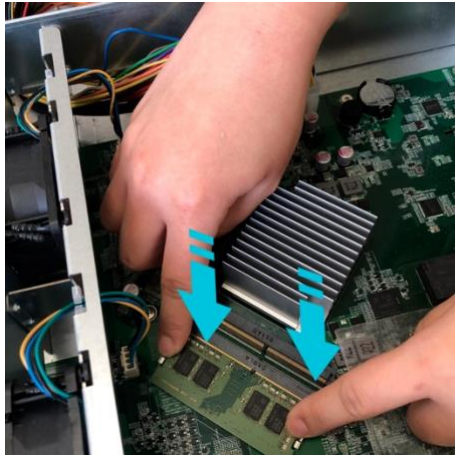

Note: Upon installation of new RAM, your ASUSTOR NAS will perform a memory check on startup. This process occurs only once and may take up to 10 minutes to complete. This is normal.

Replacing the Cover

- Replace the cover and tighten the three screws that were removed previously.

AS6504RS/AS6504RD



AS6512RD

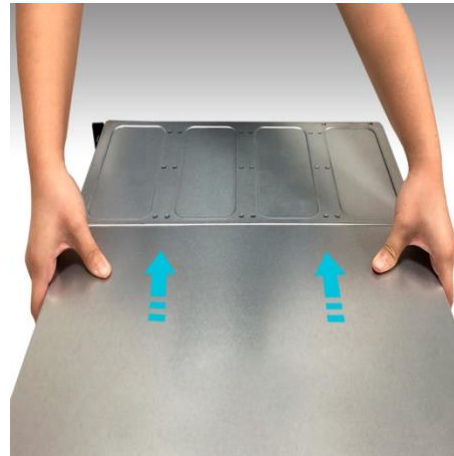

- Reconnect all cables including the power cord and then start up the NAS.

AS6504RS

AS6504RD

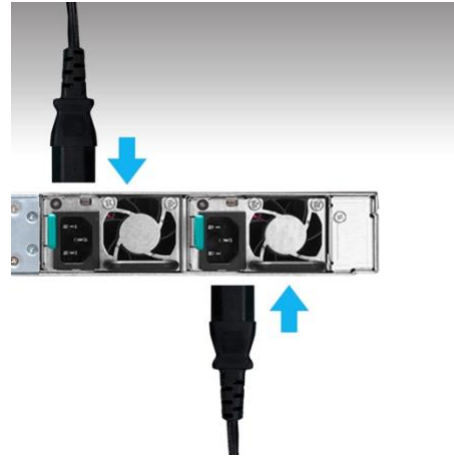

AS6512RD

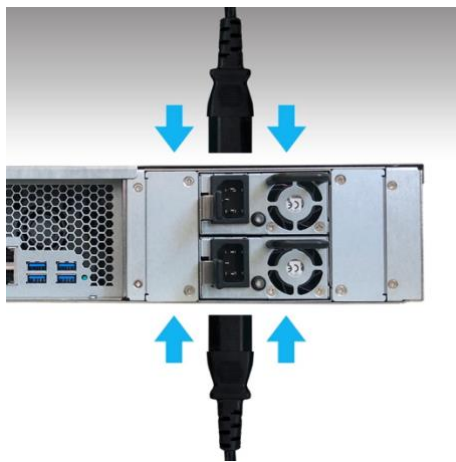

Installing Expansion Card

1. Unscrew the blanking plate retention screw and then remove the blanking plate for the expansion slot that you wish to use.

AS6504RD/AS6504RS



AS6512RD

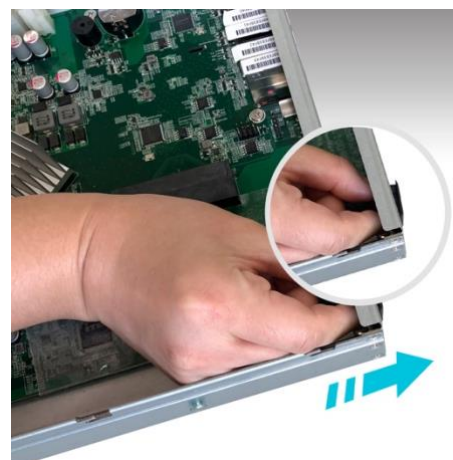

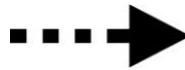
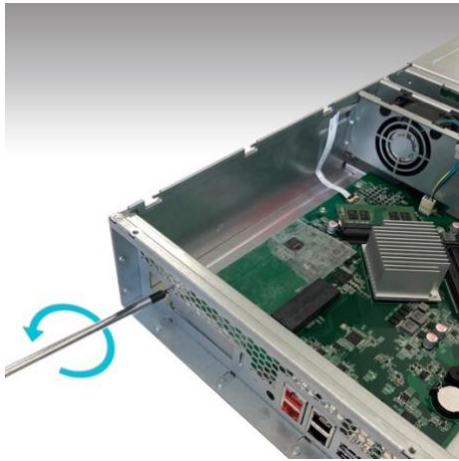

- Carefully insert your expansion card into the slot, making sure to line up the connector on the bottom of the expansion card with the slot.

AS6504RD/AS6504RS

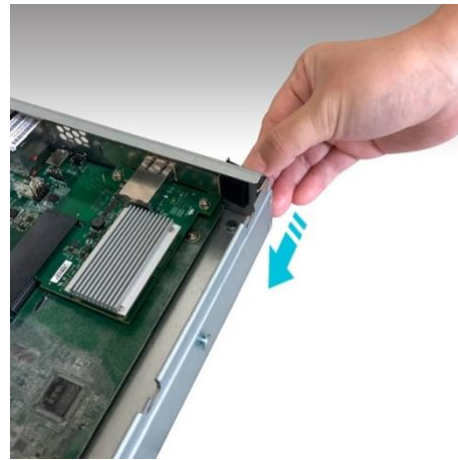
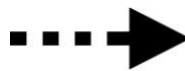

AS6512RD

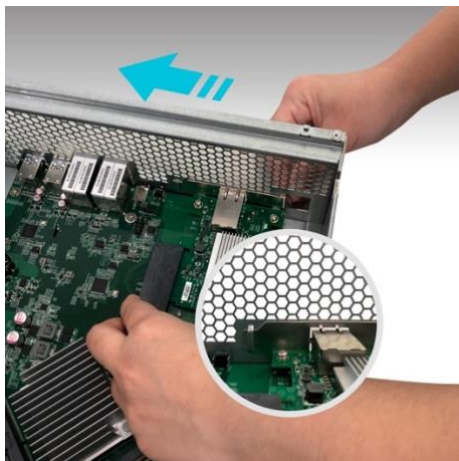

Rail Kit Installation

- Take out the two rail assemblies.

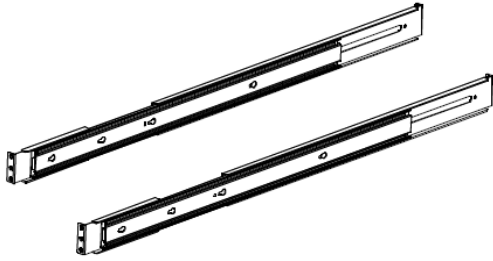

- Fully extend the rail assembly by pulling it outward.

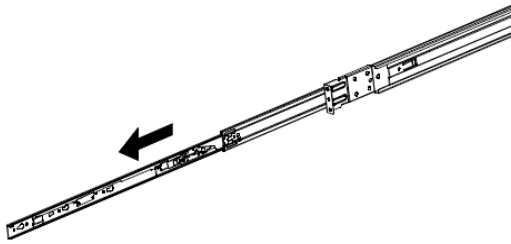

- Press down on the release tab and pull the inner rail out.

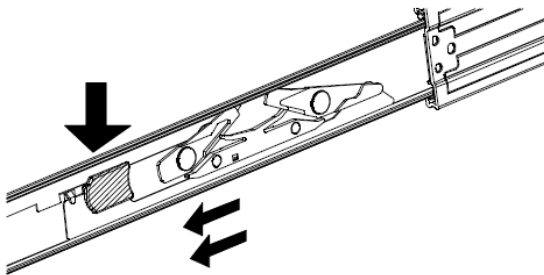

- Separate the inner rail from the outer assembly.

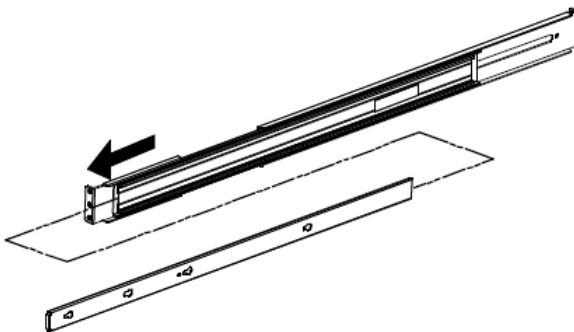

- Line up the holes on the inner rail with the pegs on the system chassis and push the inner rail all the way in.

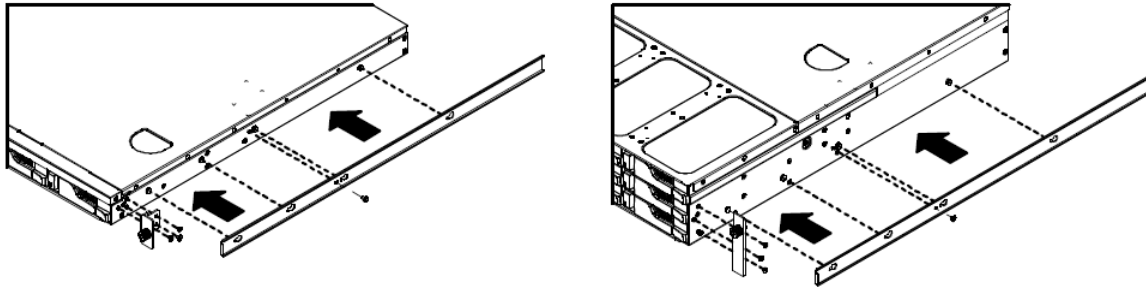

- Mount the inner rails to the system chassis using the provided mounting screws.

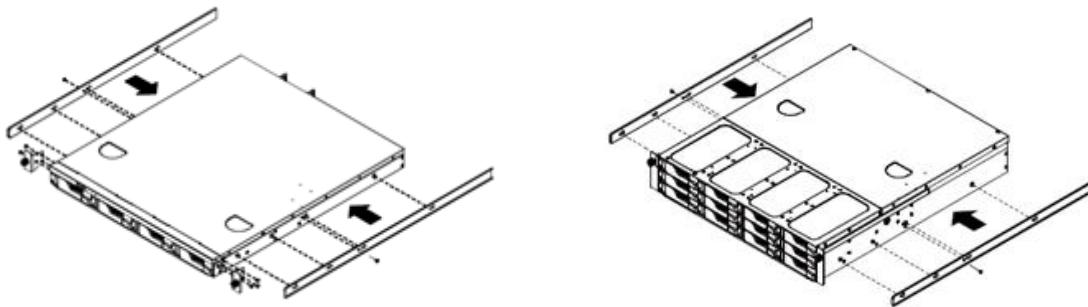

- Mount the outer rail assembly to your rack. Please note that both the front and back of the outer rail assembly will need to be fastened to the rack with two screws.

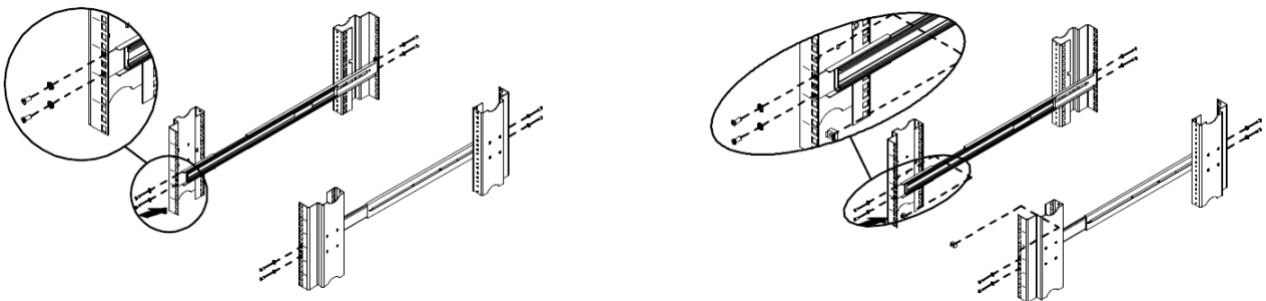

- Align the rails and push the system chassis all the way into the rack.

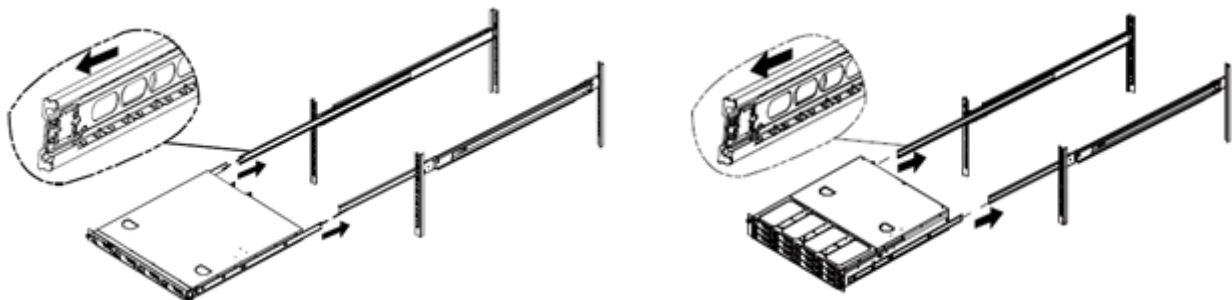

Replace Malfunctioning PSU

1. Unplug the power cord from the PSU to be replaced.

AS6504RD

AS6512RD

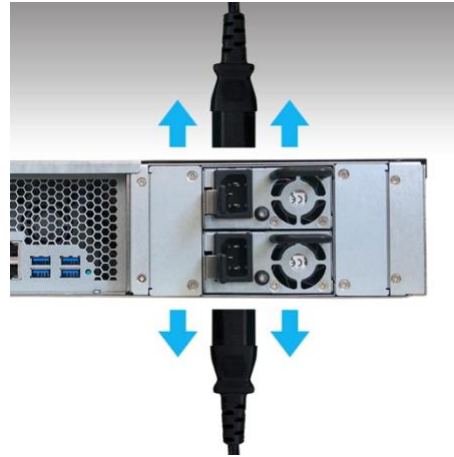
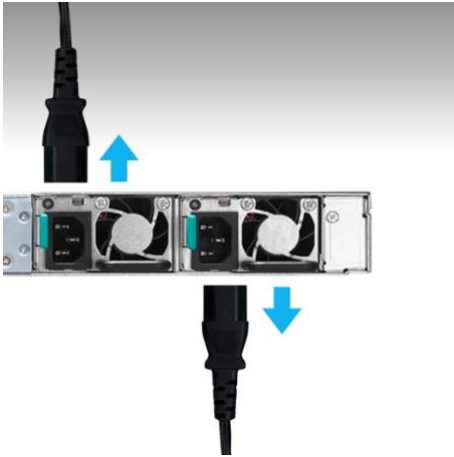

2. Push the lever of the PSU at the back panel in the indicated direction.
3. Pull out the PSU from the NAS.

AS6504RD

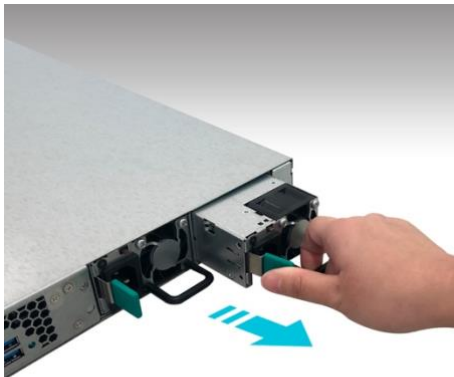

AS6512RD



4. Prepare a new PSU, and push it back to the slot until you hear a click.

AS6504RD



AS6512RD



4. Software Installation Guide

There are 4 different installation methods that you can choose from. Please select the method most suitable for you. You can go to the download section of the ASUSTOR website (<http://www.asustor.com/service/downloads>) to download the latest software.

Download Center Installation

Windows Users

1. After ASUSTOR Control Center has been installed, it will automatically begin to scan your network for ASUSTOR NAS devices.

The screenshot shows the ACC (ASUSTOR Control Center) window. At the top, there is the asustor logo and a language dropdown menu set to English. Below the logo is a navigation bar with icons for Scan, Open, Connect, ADM Update, Service, and Action. The main area displays a table of detected NAS devices.

Name	IP	Model	Serial Number	MAC Address	ADM Version	Status	Enable
AS6208T-80F7	172.16.2.35	AS6208T	AS16066210TM0007	10:bf:48:8b:80:f7	3.4.1.R7Q6	Ready	
AS3202T-LEO	172.16.9.116	AS3202T	AS16073204TM0003	10:bf:48:9b:86:99	3.4.3.B9R1	Ready	
AS6102T-87CE-MM	172.16.2.24	AS6102T	AS16076104TM0341	10:bf:48:8b:88:64	3.4.2.R932	Ready	
AS6204T-88DF	172.16.1.121	AS6204T	AS16076204TM0144	10:bf:48:8b:88:df	3.4.0.R7N3	Ready	
AS6204R	172.16.10.130	AS6204R	AS16076212RM0006	10:bf:48:8b:8b:bf	2.6.2.R6L2	Ready	
Surveillance	172.16.2.179	AS6204R	AS16076212RM0009	10:bf:48:8b:8b:b8	2.7.3.RHQ3	Ready	
AS-6212R-S	172.16.10.31	AS6212R	AS16076212RM0011	10:bf:48:8b:8b:9b	3.5.0.A9G1	Ready	
AS4004T-Jean	172.16.1.62	AS4004T	AS20180620TM0215	00:51:82:11:22:02	3.4.3.B9G1	Ready	
AS5110T-5129-S	172.16.2.77	AS5110T	AS25015110TM0000	20:14:12:10:51:2b	3.4.2.R932	Ready	
AS7008T-00r01-ri	172.16.2.10	AS7008T	AS87654321TM3333	20:14:08:27:00:01	3.5.0.A9G1	Ready	
AS6202T-AAA	172.16.2.105	AS6202T	ASUSTORRDTTEST	20:15:07:13:62:04	3.3.1.RIH2	Ready	
AS-604T-vivian	172.16.1.109	AS-604T	AT1207608MB0047	10:bf:48:89:c4:2e	3.5.0.A9R1	Ready	
AS-604T-C534	172.16.2.218	AS-604T	AT1207608MB00EA	10:bf:48:89:c5:33	3.4.3.B9K1	Ready	

2. Select your NAS from the list and follow the installation wizard's instructions to complete the configuration process.

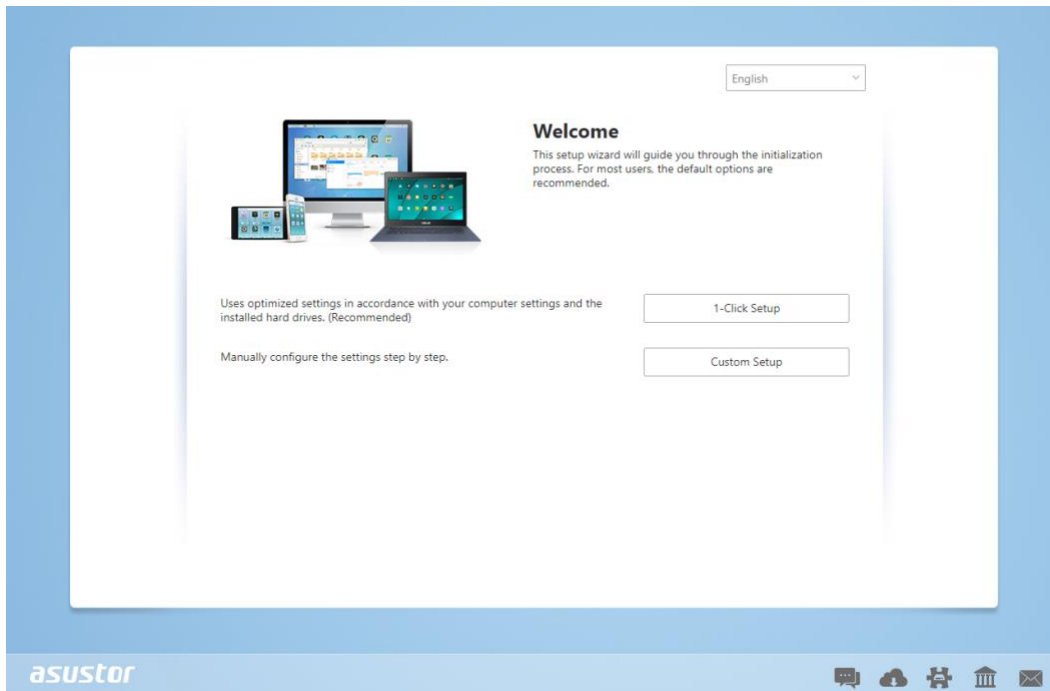

Mac Users

1. After ASUSTOR Control Center has been installed, it will automatically begin to scan your network for ASUSTOR NAS devices.

Name	IP Address	Model	Serial Number	MAC address	ADM Version	Status	WOL
AS1004T-1124-rr	172.16.1.53	AS1004T...	AL18041004EM00FB	20:18:11:15:11:24	3.4.2.R932	Ready	--
AS1002T-76BE	172.16.2.117	AS1002T...	AL18041004EM0119	10:BF:48:8C:76:BE	3.4.3.BA21	Ready	--
MARCO4004T	172.16.2.196	AS4004T	AL18054004TM00EC	10:BF:48:8C:7D:FB	3.4.1.R7Q6	Ready	--
AS4002T-RUDY	172.16.1.167	AS4002T	AL18064004TM0021	10:BF:48:8C:95:DA	3.4.2.R932	Ready	--
AS4002T-9B26	172.16.2.160	AS4002T	AL18064004TM0035	10:BF:48:8C:9B:26	3.4.3.BA21	Ready	--
AS6404T-1400TC	172.16.1.3	AS6404T	AL18076404TM0030	20:18:12:12:14:00	3.4.2.R932	Ready	--
AS1004T-LEO	172.16.2.156	AS1004T...	AL18081004EM03DF	20:19:02:19:16:1A	3.4.3.BA21	Ready	--
AS6302T-CDCF-ri	172.16.10.235	AS6302T	AL18116304TM012B	10:BF:48:8C:DC:8D	3.3.1.BHT1	Ready	--
AS6404T-DD51-AA	172.16.3.94	AS6404T	AL18116404TM005E	10:BF:48:8C:DD:51	3.4.2.R932	Ready	--
AS6404T-jinnnnnnnnnn...	172.16.1.142	AS6404T	AL18116404TM0064	10:BF:48:8C:DD:59	3.4.3.B9R1	Ready	--

2. Select your NAS from the list and follow the installation wizard's instructions to complete the configuration process.

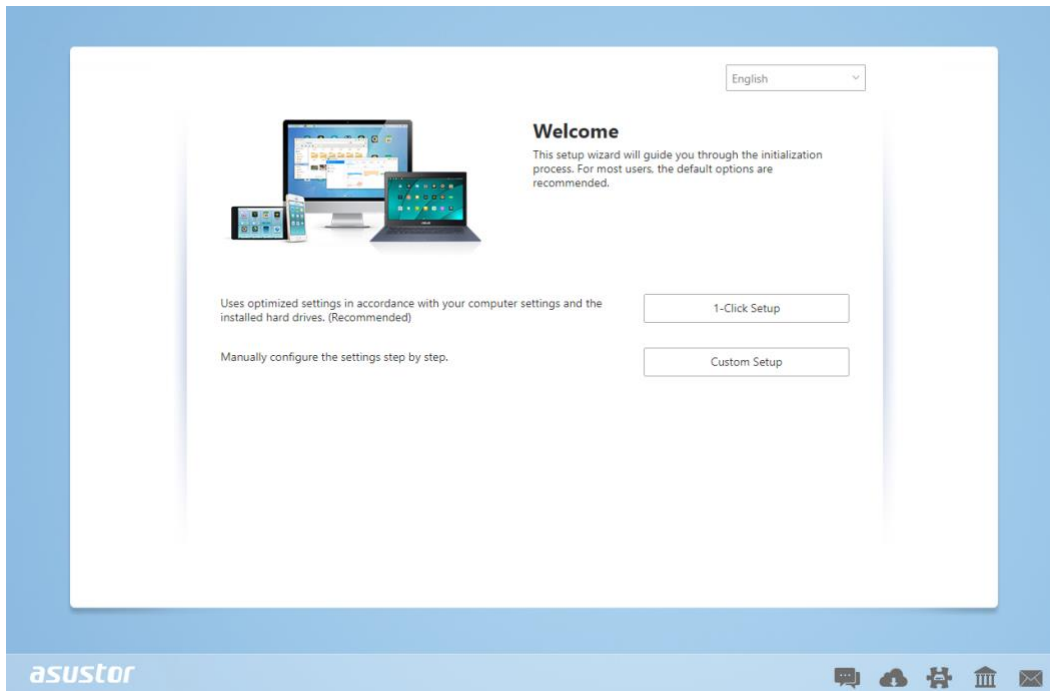

Web Installation

1. If you already know your NAS's current IP address, you can open up a web browser and enter in your NAS's IP address (for example: <http://192.168.1.168:8000>) to begin initialization.
2. Please follow the instructions from the installation wizard to complete the configuration process.

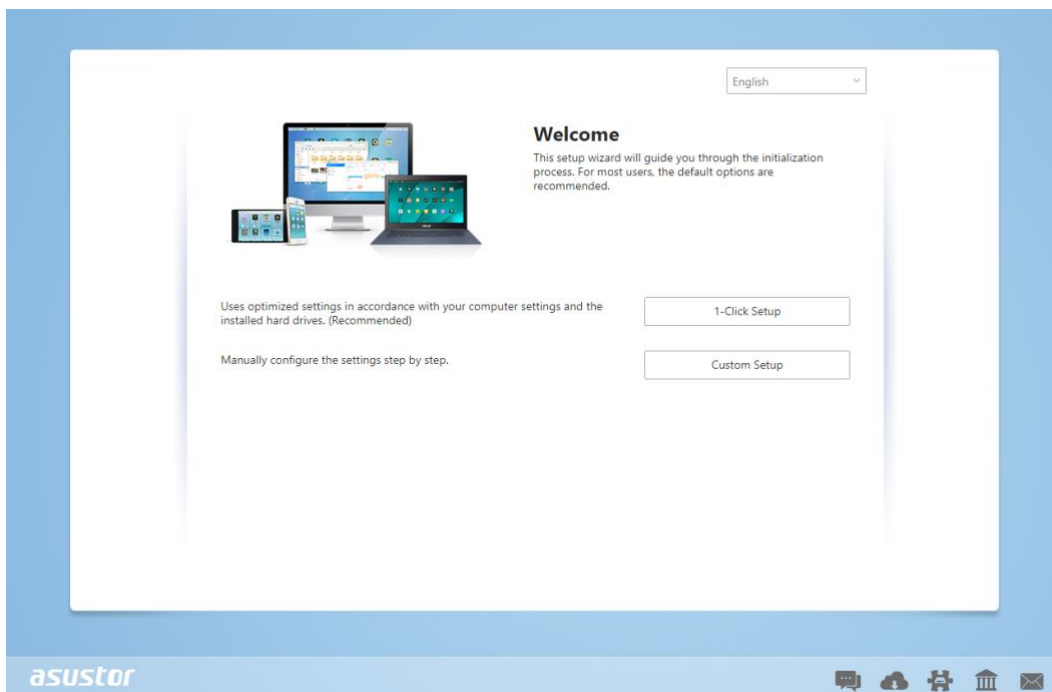

Installation Using a Mobile Device

1. Search for “**AiMaster**” in Google Play or the Apple App Store. You can also scan the QR codes provided below. Download and install the AiMaster mobile app to your mobile device.

AiMaster for Android



AiMaster for iOS



2. Make sure that your mobile device is connected to the same local network that your NAS is connected to.
3. Next, open AiMaster and then select the [+] icon from the toolbar at the top of the screen.

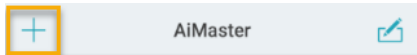

4. Select **Auto Discovery**. AiMaster will now scan the local network for your NAS.



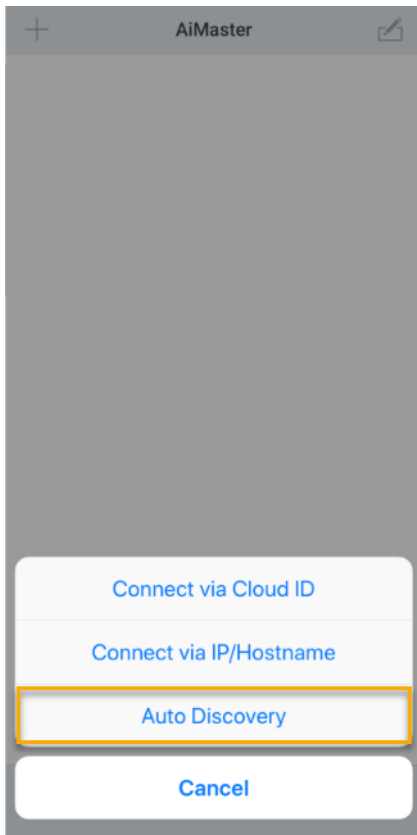

5. Select your NAS from the list that appears.

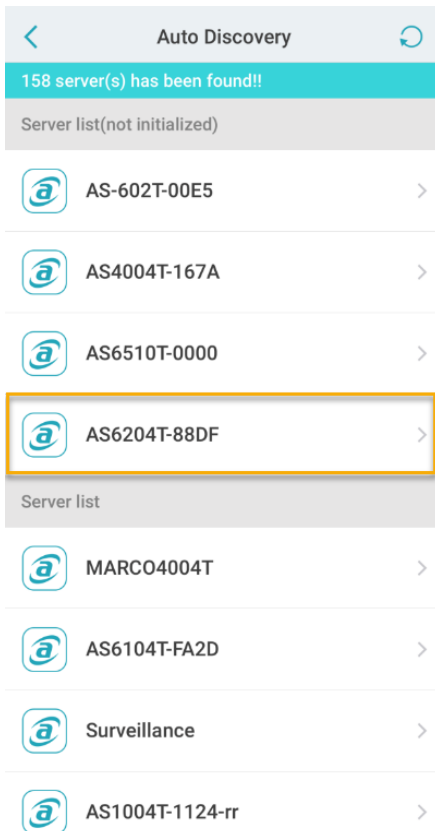

6. Select **[Start Initialization]** to begin installation. Follow the prompts and instructions to complete the configuration process.

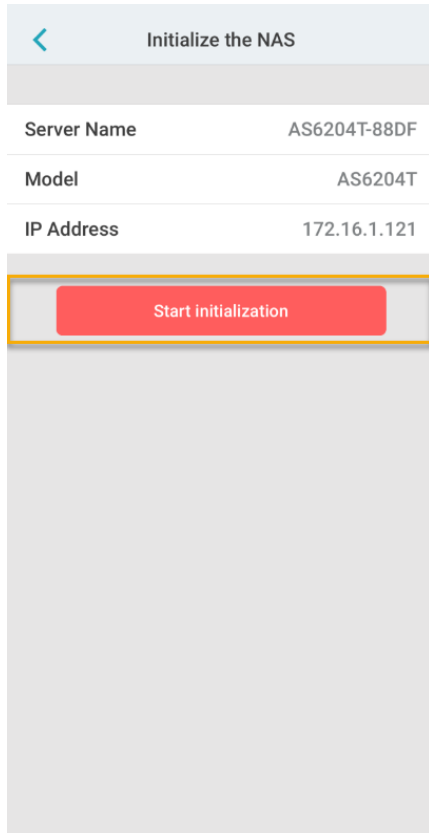

Installation Using a Direct Connection

Please see section [Troubleshooting](#) for installation instructions.

Shutting Down Your NAS

1. Confirm the function settings for the power button as shown in the graphic below. When the power button is held down for 1.5 seconds you can decide whether to shut down the NAS or have it enter into sleep mode. This setting may be access from within ADM by selecting: [Settings] → [Hardware] → [Power] → [Settings].

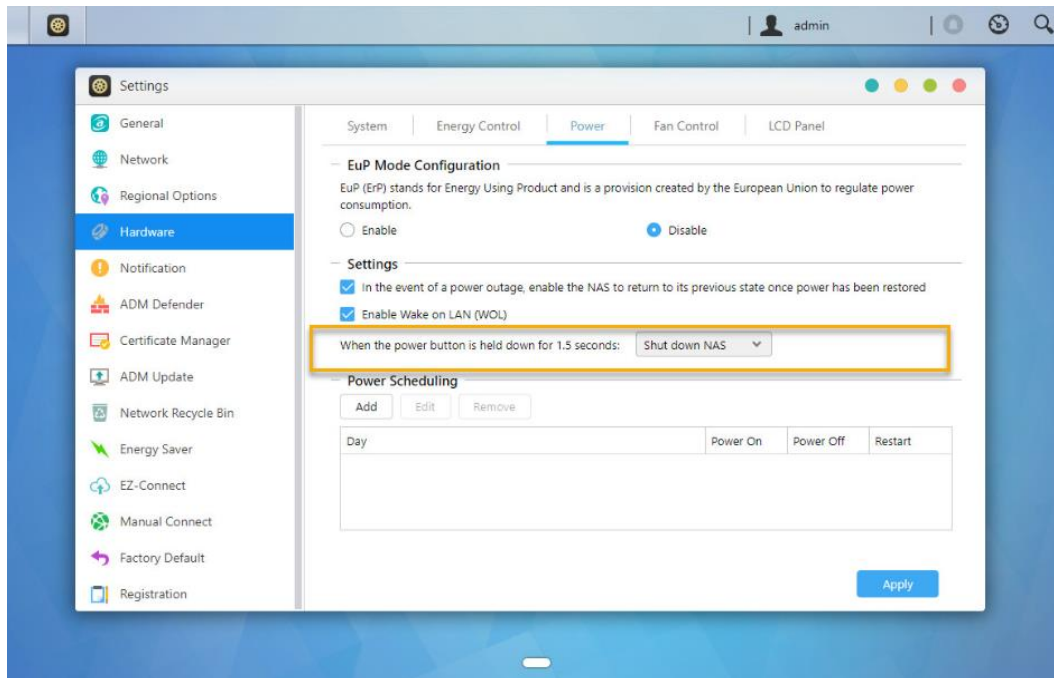

2. Hold down the power button for 1.5 seconds. You should be able to hear a “beep” from the system buzzer. Let go of the power button and the NAS will either shut down or enter sleep mode depending on your configuration.



5. Appendix

LED Indicators

AS6504RD/AS6504RS



AS6512RD





- 1** Power LED Indicator



2 Inspection LED Indicator

3 System Status LED Indicator
- 4** Network LED Indicator (*)

5 Hard Disk LED Indicator

*For AS6504RD/AS6504RS/AS6512RD models: When Ethernet cables are connected to [Ethernet Port 1] and [Ethernet Port 2] on the rear panel of the NAS, the first network LED indicator on the front of the NAS will become steadily lit. Once Ethernet cables are connected to [Ethernet Port 3] and [Ethernet Port 4] on the rear panel of the NAS, the second network LED indicator on the front of the NAS will become steadily lit.

LED Indicator	Color	Description	State
Power 	Blue	Steadily lit	Power on
	Orange	Flashes every 10 seconds	LED night mode
Inspection	Blue	Steadily lit	Inspection light activated
System Status 	Green	Flashing	Powering on

		Steadily lit	System ready
Network 	Blue	Steadily lit	Network port connected
Hard Disk 	Green	Steadily lit	Hard disk ready
		Flashing	Data access in progress
	Flashes every 10 seconds	Hibernation mode	
	Red	Steadily lit	Hard disk abnormality

Rear Panel

AS6504RD/AS6504RS

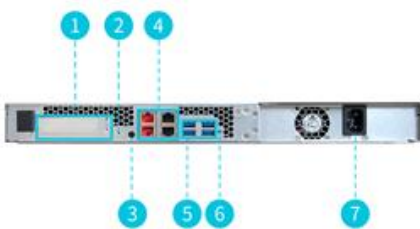
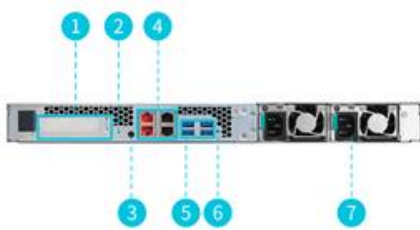

AS6512RD

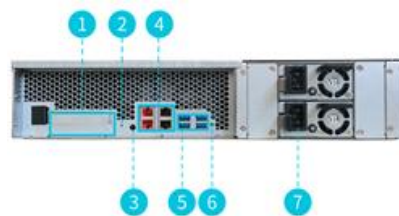

- 1** PCI Express 3.0 Expansion Slot
- 2** Reset Button
- 3** Console Port
- 4** 2.5GbE & 1GbE RJ-45 Ports

- 5** USB 3.2 Gen 1 Ports
- 6** Service LED
- 7** Power Supply Unit

Troubleshooting

Q: Why can't I detect my ASUSTOR NAS using ASUSTOR Control Center?

A: If you are having trouble detecting your NAS using ASUSTOR Control Center, please do the following:

1. Please check your network connection:
 - ✓ Make sure that your computer and your NAS are part of the same local area network.
 - ✓ Check to see if the network LED indicator is lit. If you find that it is not lit, try connecting your Ethernet cable to the other network port or try using a different Ethernet cable.
 2. Please first disable any firewalls that may be running on your computer. Then try scanning for your NAS again using ASUSTOR Control Center.
 3. If you still cannot detect your NAS, please connect your NAS to your computer using the provided RJ-45 network cable and change your computer's IP settings.
- ✓ Select **[Start]** → **[Control Panel]** → **[Network and Sharing Center]**

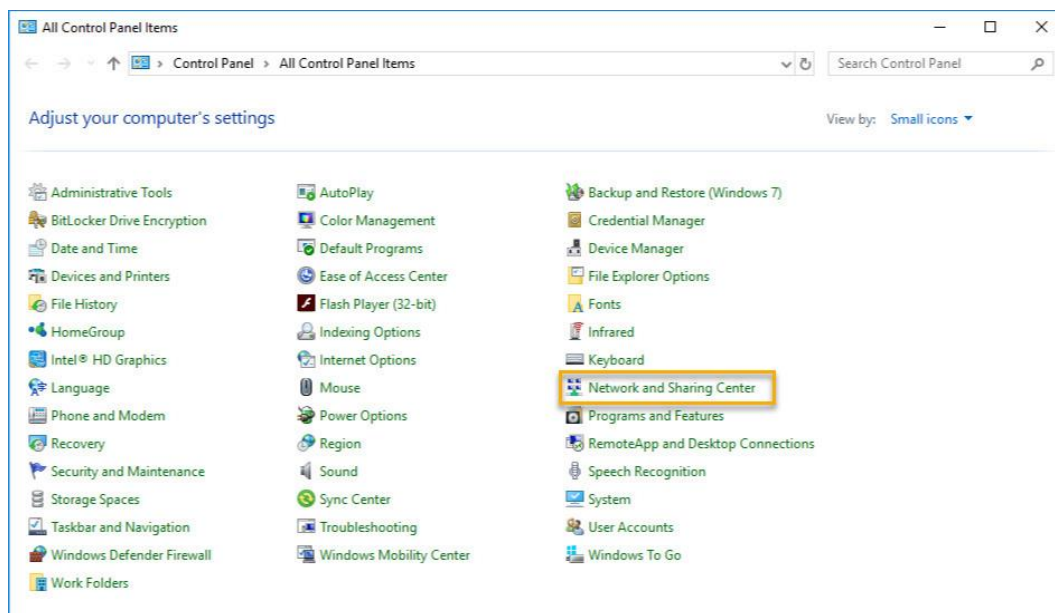

- ✓ Click on **[Change adapter settings]** in the left hand panel.

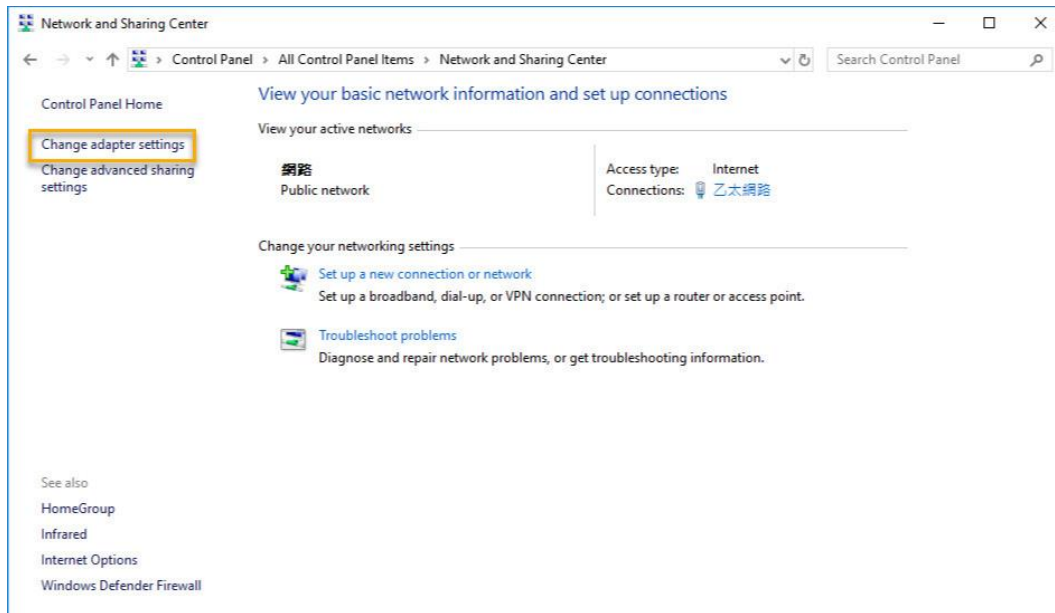

- ✓ Right-click on **[Local Area Connection]** and select **[Properties]**.

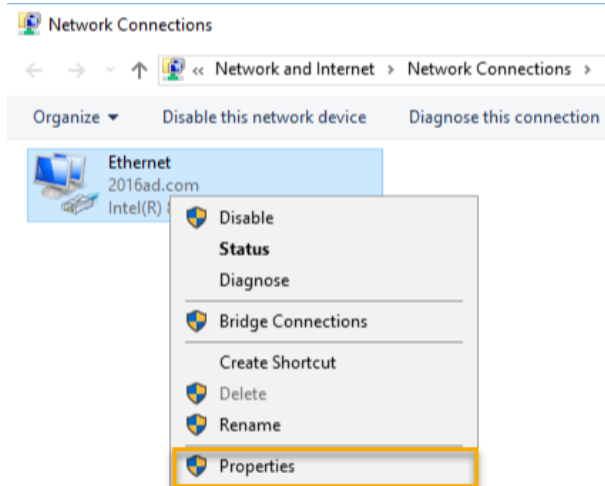

- ✓ Under the **[Networking]** tab select **[Internet Protocol Version 4 (TCP/IPv4)]** and click on **[Properties]**.

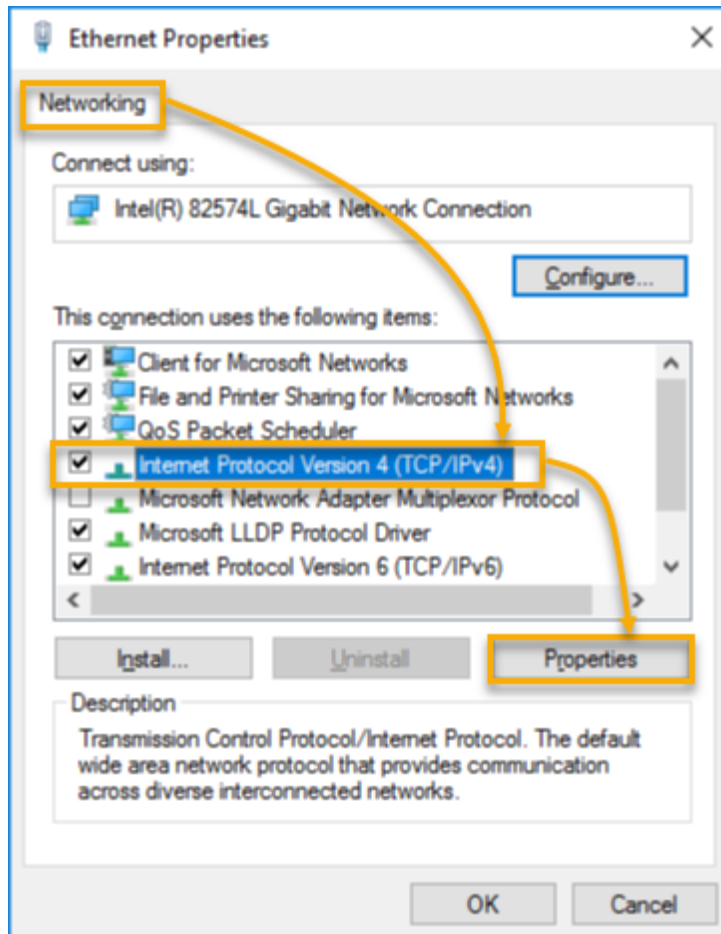

- ✓ Under the **[General]** tab select the **[Use the following IP address]** radio button. Set the **[IP address]** to **169.254.1.1** and the **[Subnet mask]** to **255.255.0.0** and then click on **[OK]**.

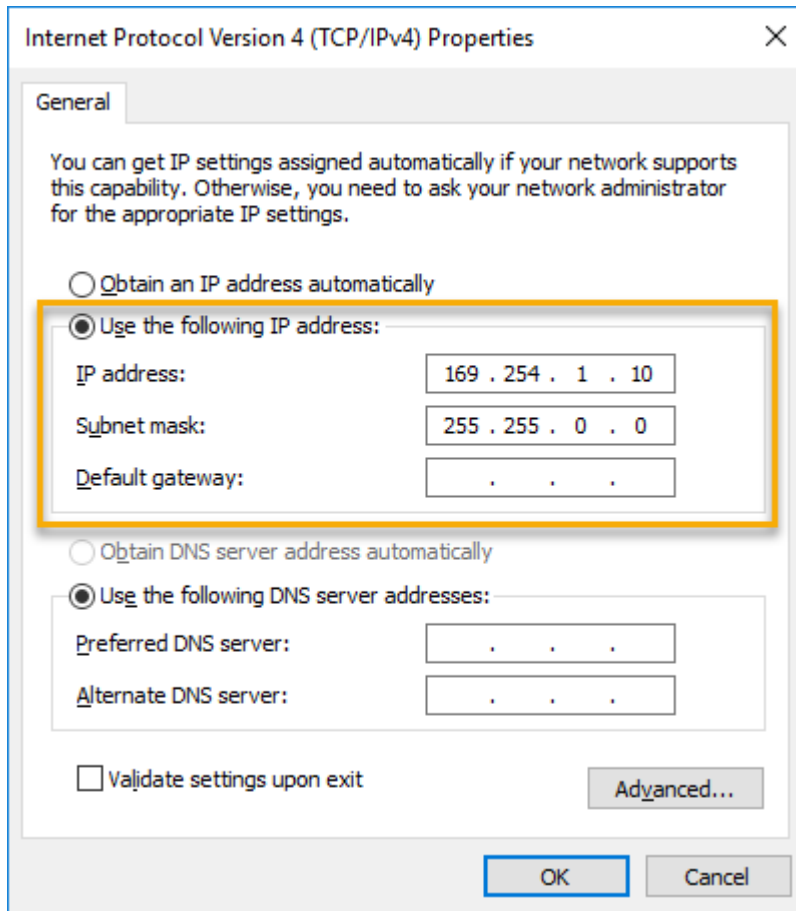

- ✓ Open up ASUSTOR Control Center to scan for your NAS.

Name	IP	Model	Serial Number	MAC Address	ADM Version	Status	Enable
AS6208T-80F7	172.16.2.35	AS6208T	AS16066210TM0007	10:bf:48:8b:80:f7	3.4.1.R7Q6	Ready	
AS3202T-LEO	172.16.9.116	AS3202T	AS16073204TM0003	10:bf:48:9b:86:99	3.4.3.B9R1	Ready	
AS6102T-87CE-MM	172.16.2.24	AS6102T	AS16076104TM0341	10:bf:48:8b:88:64	3.4.2.R932	Ready	
AS6204T-88DF	172.16.1.121	AS6204T	AS16076204TM0144	10:bf:48:8b:88:df	3.4.0.R7N3	Ready	
AS6204R	172.16.10.130	AS6204R	AS16076212RM0006	10:bf:48:8b:8b:bf	2.6.2.R6L2	Ready	
Surveillance	172.16.2.179	AS6204R	AS16076212RM0009	10:bf:48:8b:8b:b8	2.7.3.RHQ3	Ready	
AS-6212R-S	172.16.10.31	AS6212R	AS16076212RM0011	10:bf:48:8b:8b:9b	3.5.0.A9G1	Ready	
AS4004T-Jean	172.16.1.62	AS4004T	AS20180620TM0215	00:51:82:11:22:02	3.4.3.B9G1	Ready	
AS5110T-5129-S	172.16.2.77	AS5110T	AS25015110TM0000	20:14:12:10:51:2b	3.4.2.R932	Ready	
AS7008T-00r01-ri	172.16.2.10	AS7008T	AS87654321TM3333	20:14:08:27:00:01	3.5.0.A9G1	Ready	
AS6202T-AAA	172.16.2.105	AS6202T	ASUSTORRDTEST	20:15:07:13:62:04	3.3.1.RIH2	Ready	
AS-604T-vivian	172.16.1.109	AS-604T	AT1207608MB0047	10:bf:48:89:c4:2e	3.5.0.A9R1	Ready	
AS-604T-C534	172.16.2.218	AS-604T	AT1207608MB00EA	10:bf:48:89:c5:33	3.4.3.B9K1	Ready	

4. If the above mentioned procedures have not managed to solve your problem, please contact your local ASUSTOR dealer or ASUSTOR Customer Service <http://support.asustor.com>. You are also encouraged to browse through the [ASUSTOR Knowledgebase](#).



SUPPORT.ASUSTOR.COM